

STAINLESS STEEL THREE PHASE MOTOR

Model SS134UF

Voltage <u>208-230/460</u>	Hz <u>60</u>	Shaft Material <u>304 Stainless Steel</u>	Design <u>B</u>
Phase <u>3</u>	Encl <u>TEFC</u>	Ambient <u>40°C</u>	Duty Cycle <u>S1</u>
IP <u>69K</u>	KVA <u>K</u>	Altitude <u>3300FT</u>	Rotation <u>CW/CCW</u>
	Ins. Cl. <u>F</u>	Mounting <u>F1</u>	Inverter Duty <u>10:1 CT 20:1 VT</u>

HP	RPM	S.F.	Frame	Amps 208-230/460 V		Locked Rotor Amps	No Load Current	Lead / Connect	Moment of Inertia	Temp. Rise, °C
0.33	1780	1.15	56C	1.57-1.42/0.71		9.45/4.73	1.23/0.65	9 / Y	—	80
Bearing		Efficiency, %		Power Factor		Rated Torque, lb.ft.	Locked Rotor Torque, %	Breakdown Torque, %	Max Time Locked Rotor	Weight, lbs
DE	ODE	FL	3/4L	FL	3/4L					
6203ZZ	6203ZZ	75	74.3	0.57	0.47	0.998	301	424	16 Sec	31

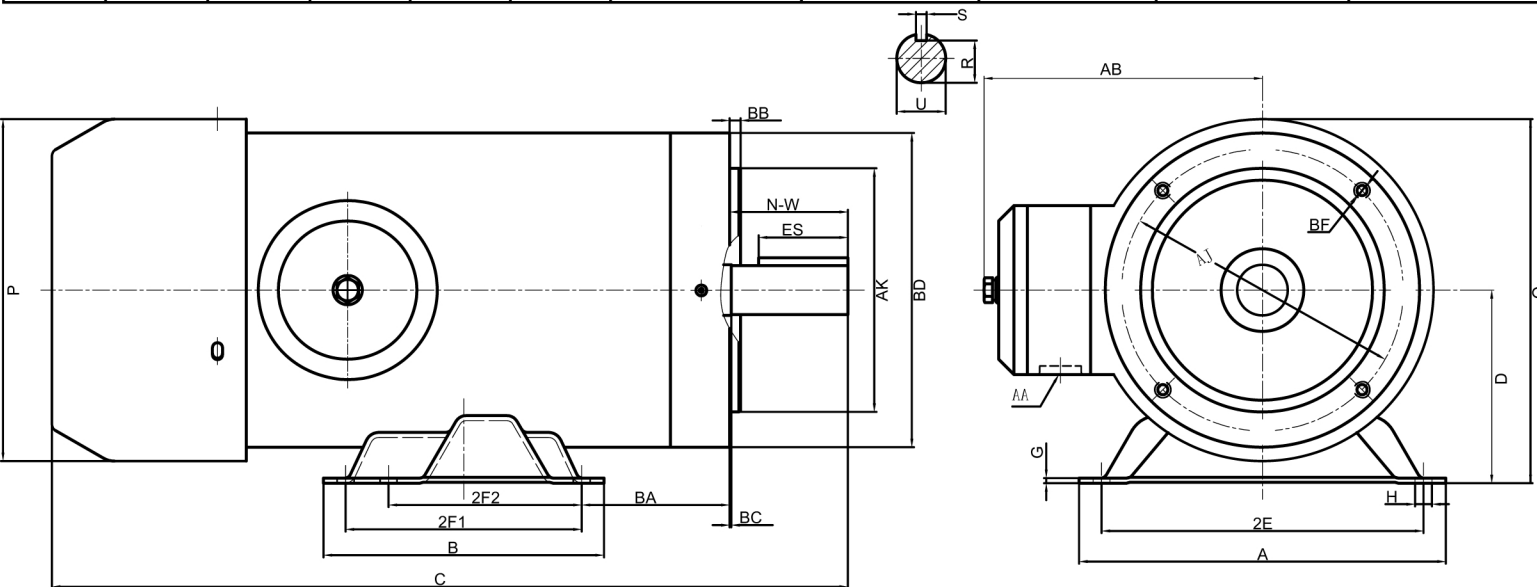

Dimensions in inches

A	B	C	D	G	H	O	P	AB
6.5	3.94	11.76	3.5	0.12	0.34	6.73	6.85	5.93
R	S	AK	BD	BB	BC	AJ	AA	BF
0.517	0.188	4.5	6.46	0.16	0.12	5.875	3/4	3/8-16
SHAFT EXTENSION			MOUNTING					
N-W	U	ES	2E	2F1	2F2	BA		
1.88	0.625	1.41	5.5	—	3	2.75		

Rating for 50Hz Application	
HP	0.24
RPM	1470
Volt	200/400
S.F.	1.0

